

**tarm**<sup>®</sup>  
professional luminaires

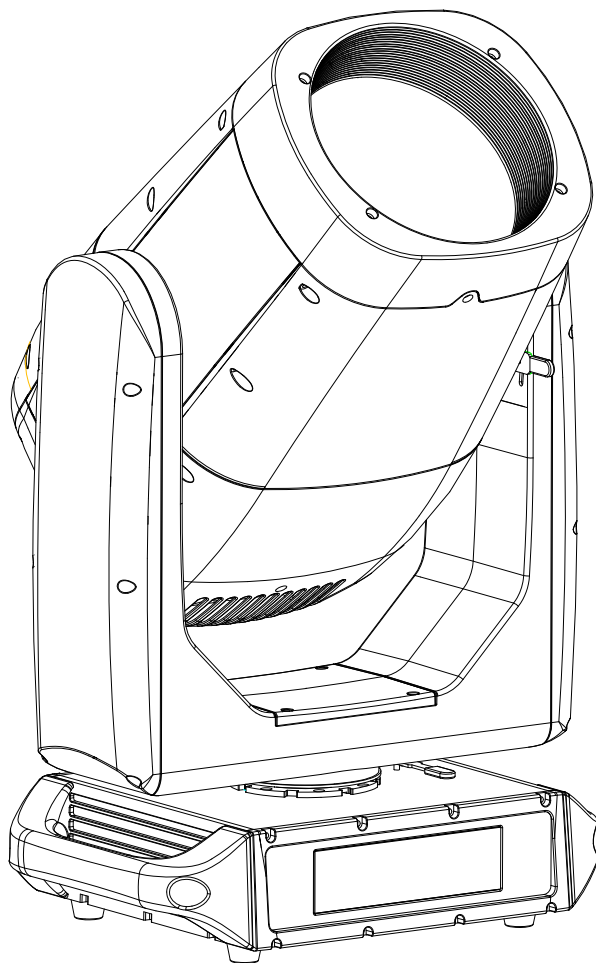

***BLAZE***

User Manual

## Overview

1.	GETTING STARTED	3
2.	BOX CONTENTS	3
3.	INFORMATION ON WATERPROOF LUMINAIRE	3
4.	SAFETY INSTRUCTIONS - GENERAL SAFETY	3
5.	SAFETY INSTRUCTIONS - HANDLING THE FIXTURE	5
6.	TRANSPORTATION	6
7.	INSTALLATION	6
7.1.	RIGGING	6
7.2.	REPLACING THE FUSE	8
7.3.	POWER CONNECTION	8
8.	SETTINGS	9
8.1.	DISPLAY CONTROL	9
8.2.	MENU LAYOUT	10
9.	DMX-CHART - CONTROLS	13
10.	W-DMX OPERATION	16
11.	COLORS	17
11.1.	COLOR WHEEL	17
11.2.	CMY COLOR MIXTURE	17
12.	GOBOS	18
12.1.	STATIC GOBOS, WITH GOBO SHAKE	18
12.2.	ROTATING GOBOS, EFFECTS	19
13.	PRISMS	19
13.1.	PRISM 1 - LINEAR PRISM	19
13.2.	PRISM 2 - RADIAL PRISM	19
14.	FROST	19
15.	DIMENSIONS	20
16.	FLIGHTCASE INLAY - HIGH DENSITY PU FOAM SHELL	21
17.	TECHNICAL DATASHEET	22
18.	GENERAL AND LEGAL INFORMATION	23

## 1. GETTING STARTED

Please make sure to carefully read and fully understand the instructions in this manual before operating this device. It includes essential information on safety and usage.

**This device should only be operated by trained personnel and is not intended for private use.**

## 2. BOX CONTENTS

- 1 x tarm BLAZE luminaire
- 1 x Power cable
- 2 x Omega brackets
- 1 x PU foam as inlay for your custom flightcase (flightcase not included)

## 3. INFORMATION ON WATERPROOF LUMINAIRE

The tarm BLAZE luminaire is an IP66 rated, waterproof device. It is protected against dust and water ingress. Thus any maintenance or service work that incorporates the opening of the device requires additional procedures to ensure the waterproofness after the maintenance or service work. Please see the maintenance procedures further down this manual.

**Even though this device can endure ingress of dust (6) and powerful water jets from any direction (6) (-> IP66), it is not submersible and not suitable for underwater operation.**

### **Maritime/Coastal Environment Installations:**

Coastal environments, located near the sea, expose electronics to atomized saltwater and high humidity, posing a significant corrosive risk. Maritime settings include areas within a 5-mile radius of these coastal environments.

Due to these challenging conditions, maritime installations require additional precautions and more frequent servicing. It's important to note that IP ratings are initially based on fresh-water conditions, whereas maritime environments are generally more corrosive to IP fixtures, both internally and externally. During periods of high humidity and low temperatures, periodic operation may be necessary to expel accumulated moisture through the vent valve. Recommendations may vary depending on specific installation circumstances.

## 4. SAFETY INSTRUCTIONS - GENERAL SAFETY

This fixture is an advanced piece of electronic equipment. To ensure optimal performance, it's crucial to adhere to all instructions and guidelines provided in this manual.

**The tarm AG cannot be held liable for any injuries or damages resulting from misuse or neglect of the information provided.** Installation should only be carried out by **qualified or certified personnel**, using exclusively the **original rigging parts** (omega brackets) included

with the fixture. Any alterations to the fixture or its mounting hardware will void the manufacturer's warranty and **elevate the risk of damage or personal injury**. All local requirements for safe rigging and mounting of lighting fixtures must be observed.

This device contains a **laser-based light source** that is considered a substitution of a conventional light source according to IEC / EN 60825-1:2022 chapter 4.4. Therefore this luminaire is classified as **Laser Class 1**, and assigned to Risk Group 3 according to IEC / EN 62471:2006, modified.

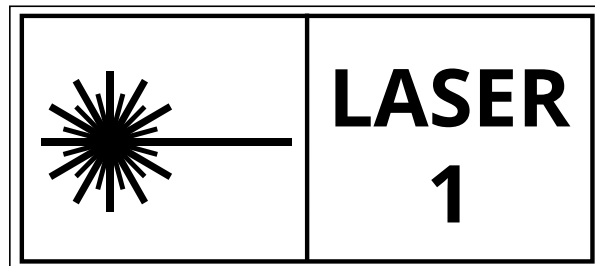

- A **Class 1 Laser** is considered **safe** according to IEC / EN 60825-1:2022 chapter C.2.1.
- Risk Group 3 (high risk): This luminaire is classified as a Risk Group 3 product according to IEC / EN 62471:2006, modified. That means, that the high intensity of the output can potentially cause various hazards to people and objects. Certain minimum distances must be respected
  - to people: 34 m for wide focus use, 47 m for close focus use
  - to objects: minimum 1m to heat insensitive / non flammable and non-reflective materials, 20m to easily flammable materials or reflective materials.

Caution: If the luminaire is operated with the housing of the device opened, laser radiation of Laser Class 3B can be emitted. **Only qualified and trained personnel to open and service the device! Never open the device while in use!**

- **There are no user serviceable parts inside this luminaire.**  
Do not attempt any repairs yourself. Damages resulting from modification to this luminaire void the manufacturer's warranty. Disregarding safety instructions in this manual also void the manufacturer's warranty and are not subject to any warranty claims and / or repairs.
- **Do not plug device to a dimmer!**
- **Keep flammable materials away** from the fixture.
- **Never obstruct the ventilation / cooling system** of the device - it may cause damage or destruction and can cause additional hazards. Obstructing the ventilation of the device voids any warranty.
- **Never look directly into the light source** (see minimum distance to people specified above). Risk of retina injuries, temporary or even permanent blindness.

- Sensitive persons may suffer **epileptic shock!**
- All unused connectors and caps must be sealed with appropriate dielectric grease to prevent corrosion of connectors.



This device has been tested and found to comply with the limits for a Class A digital device, pursuant to Part 15 of the FCC Rules. These limits are designed to provide reasonable protection against harmful interference when the equipment is operated in a commercial environment. This equipment generates, uses and can radiate radio frequency energy and, if not installed and used in accordance with the instruction manual, may cause harmful interference to radio communications. Operation of this equipment in a residential area is likely to cause harmful interference in which case the user will be required to correct the interference at his own expense.

## 5. SAFETY INSTRUCTIONS - HANDLING THE FIXTURE

- Handle the **power cord** by the **plug end only**; never pull the plug out by tugging on the wire.
- Do not touch the fixture housing during operation. Turn off the power and allow approximately 15 minutes for the **fixture to cool down before servicing**.
- Avoid shaking the fixture and **do not use brute force during installation** or operation.
- **Do not operate** the fixture if the **power cord is frayed, crimped, damaged**, or if any of the **connectors are compromised** and cannot be securely and easily inserted into the fixture.
- **Never force a power cord connector into the fixture**. If the power cord or any of its connectors are damaged, replace them immediately with a new cord of similar power rating.
- **Do not block any air ventilation slots**. Ensure that all fan and air inlets remain clean and unobstructed.
- Maintain approximately 25 cm of space between the fixture and other devices or walls for proper cooling, and a minimum of 50 cm around fans and air vents.
- When installing the fixture in a suspended environment, always use mounting hardware no less than M10x25mm, and **secure the fixture with an appropriately rated safety cable**.
- Consistent operational breaks will help ensure the fixture functions properly for many years.
- Use only the **original packaging and materials when transporting** the fixture for service.
- **Never exceed** the specified **minimum and maximum operating temperatures** specified in the technical data. This may lead to damage or total break of the device and can furthermore lead to secondary hazards (fire, short circuit, etc.). Operating the device beyond the specified operating temperature range voids the manufacturer's warranty.

- **Do not install a fuse** that has a **higher rating** than the one originally installed in the product.
- **Do not bypass fuses.**
- **Do not stick filters, masks or other materials** onto optical components.
- **Do not point** the front of the fixture **towards the sun** or other strong light sources. The front lens focuses and concentrates light just like a magnifying glass. Strong light can cause internal damage to the fixture, melting components or starting an internal fire within seconds.
- **Avoid pointing other high powered beam lights directly at the fixture.**
- **Do not focus a light beam from one lighting fixture directly towards another.**
- **For outdoor applications during daylight, make sure that the front face of any fixture is shielded** or points away from the sun, even when not in use.
- Do not expose the product to heat (from other lighting fixtures for example).

## **6. TRANSPORTATION**

- Only transport the device **using the PU foam included** in delivery or comparable.
- Only transport it with the **locks for Pan and Tilt movement applied.**
- Only transport the device with the **base to the top as per the PU-foam.**
- **Avoid upside-down transportation** (base to the bottom), as the PU-foam was not made for this.
- **Avoid tipping the flightcase** containing the device during transport and handling.

## 7. INSTALLATION

### 7.1. Rigging

- Always install a **safety cable** in case of overhead use of the device. Follow local requirements regarding durability, length and design of the cable.
- Secure the fixture with a safety cable through the rear safety eye and truss as shown.
- Ensure that the structure (truss) to which you are attaching the fixture is secure and is dimensioned to handle dynamic fixtures.

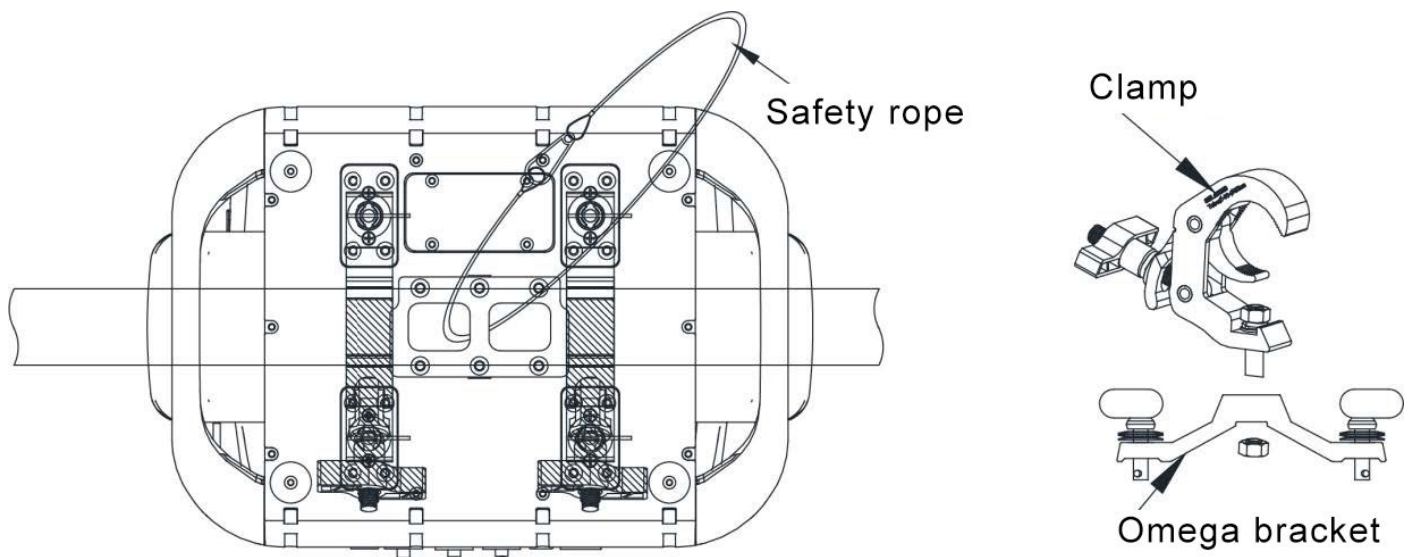

## 7.2. Replacing the fuse

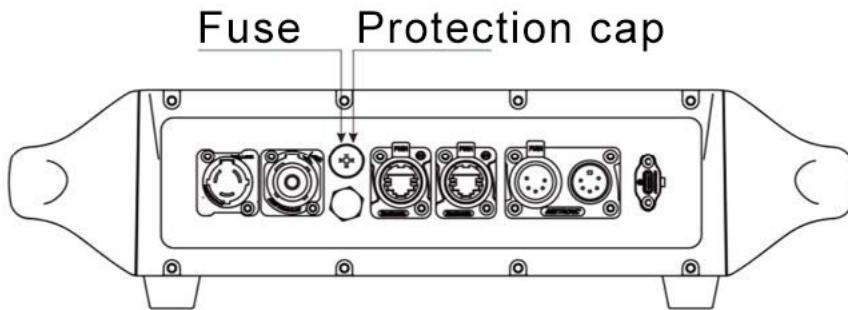

1. Remove the protection cap with a screwdriver.
2. Remove the old fuse from the cap
3. Install the new fuse.
4. Put the protection cap with the fuse back in place and make sure it is properly locked in place and tight. Do not overtighten.

## 7.3. Power connection

This product has an auto-ranging power supply that can work with an input voltage range of 100V - 240V AC, 50/60 Hz.

Never connect this product to a dimmer!

You may use the PowerCon TRU1 outlet for power connection of further tarm BLAZE fixtures. Depending on mains voltage, the maximum quantity of connected fixtures shall not exceed 15 devices (for 230V AC operating) and max 8 devices (for 100V AC operating).

If other devices are connected to the PowerCon TRU1 outlet, make sure to not exceed the total power consumption rating of the main fuse, but maximum 16A. Make sure to take a higher startup current draw of some fixtures into consideration.



## 8. SETTINGS

### 8.1. Display Control

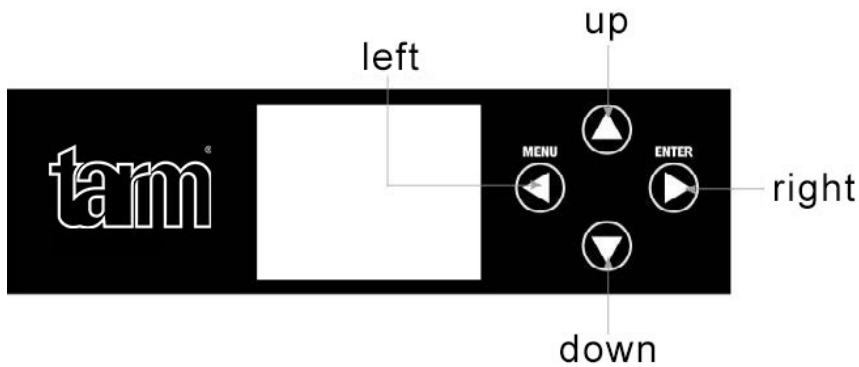

5. **LEFT (Menu)** - Use to access the menu or to return a previous menu option
6. **RIGHT (Enter)** - Use to select and store the current selection or confirm the current function value or option
7. **UP** - Navigates upwards through the menu list and increases the numeric value in certain submenu options
8. **DOWN** - Navigates downwards through the menu list and decreases the numeric value in certain submenu options

If the display is locked, unlock as follows:

1. Press and hold Enter for about 5 seconds, until the display shows „password“.
2. Standard password:  
up - down - up - down  
then press enter to unlock

## 8.2. Menu Layout

ADDRESS	001 - 512		Set the DMX address of the fixture
PERSON	BASIC		19 DMX channel operation
	STANDARD		23 DMX channel operation
	EXTEND		27 DMX channel operation
RUNMODE	DMX512		Operation mode set to DMX 512
	ARTNET		Operation mode set to Art-Net
	ARTNET TO DMX		Operation mode set to Art-Net, but outputting DMX from the DMX port ("node" functionality)
	sACN		Operation mode set to streaming-ACN
	AUTO		Automatic operation mode
	CUSTOM1		Custom operation mode 1
	CUSTOM2		Custom operation mode 2
OPTION	PAN INVERT	NORMAL	Horizontal movement normal
		INVERT	Horizontal movement inverted
	TILT INVERT	NORMAL	Vertical movement normal
		INVERT	Vertical movement inverted
	PERFORM	STUDIO	Stealth mode: Slow head movement speed, about 30% of the maximum fan speed. The motors can be slowed down. The noise level is controlled to stay below 40 dB
		POWER	Fast head movement possible, maximum fan speed is used most of the time. Noise level around 55 dB
		LIVE	Automatic speed adjustment, intelligent adjustment of fan speed. Noise level usually around 50 dB
	BLACKOUT	OFF	Blackout with delay
		ON	Blackout without delay
	DIMMER	DIM4	
		DIM3	
		DIM2	
		DIM1	
		OFF	
	LED PWM	1200Hz	default
		2400Hz	
		4000Hz	
		6000Hz	
		25000Hz	
	DMX ERROR	SAVE	Hold last control in case of DMX signal loss
		BLACK	Blackout in case of DMX signal loss
	DISPLAY TIME	On	Display permanently on
		30s	Dark display after 30s (default)
		1min	Dark display after 1min
		2min	Dark display after 2min
	DISPLAY LOCK	OFF	No display lock
		ON	Lock display with password, button combination password required for unlocking
	LOAD PARA	OFF	No parameter upload
		ON	Upload parameters
	SETTING	RECOVERY	****
CLEAN EDIT1		****	Clear edit scenario 1, Enter the correct password
CLEAN EDIT2		****	Clear edit scenario 2 Enter the correct password
WDMX HIDE		YES	If wireless is hidden, the W-DMX RESET and SIGNAL menus disappear and the signal defaults to wired only mode
NETWORK	NET SWITCH	2.xxx.xxx.xxx/10.xxx.xxx.xxx	Setup the IP address range
	UNIVERS	0-255	Set the Art-Net universe
	IP MODE	DEFAULT IP	Default IP mode (assigned IP according to standard)
		CUSTOM IP	Custom IP setting mode
	CUSTOM IP	XX.XX.XX.XX	Custom IP setting
PT ENCODER	OFF		
	ON	Switch XY encoder	
LANGUAGE	****	ENGLISH	
WDMX RESET	YES	Select to match with W-DMX transmitter, it clears the receiver pairing and re-connects	
	NO		
SIGNAL	ONLY XLRDMX	Wired signal only	
	XLRDMX FIRST	Wired signal has priority	
	ONLY WDMX	Wireless signal only	
	WDMX FIRST	Wireless signal has priority	
	WDMX TO XLRDMX	Wireless signal to wired signal - throughputs wireless signal to DMX out port	

# tarm BLAZE - User Manual



EDIT	EDIT 1-2	STEP 1-30	PAN	0-255	Allows for editing the Custom 1 and Custom 2 settings (basic stand alone scene)
			TILT	0-255	
			PT SPEED	0-255	
			CMY_C	0-255	
			CMY_M	0-255	
			CMY_Y	0-255	
			COLOR	0-255	
			ROTA.GOBO	0-255	
			GOBO.ROTA	0-255	
			FIXED GOBO	0-255	
			PRISM 1	0-255	
			PRISM 2	0-255	
			FROST	0-255	
			FOCUS	0-255	
DIMMER	0-255				
STROBE	0-25				
TIME	0-255				
USE	YES/NO				
MANUAL	AUTO TEST			Auto test	
	CHANNEL	PAN	0-255	Manual control, Channel test	
		TILT	0-255		
		PT SPEED	0-255		
		CMY_C	0-255		
		CMY_M	0-255		
		CMY_Y	0-255		
		COLOR	0-255		
		ROTA.GOBO	0-255		
		GOBO.ROTA	0-255		
		FIXED GOBO	0-255		
		PRISM 1	0-255		
		PRISM 2	0-255		
		FROST	0-255		
		FOCUS	0-255		
	DIMMER	0-255			
	STROBE	0-25			
	DEBUG HIDE	YES	Factory debugging mode		
	NO				
RESET	ALL RESET	Reset all settings			
	XY RESET	Reset Pan/Tilt			
	COLOR SYS	Reset all color system components: CMY and color wheel			
	GOBO SYS	Reset all gobo system components: fixed gobo, rotating gobo			
	OTHER	Resets all other features			
INFO	FIXTURE HOURS		Operating hours		
	LED USE HOURS		Light engine operating hours		
	TEMPERATURE		Light engine temperature		
	VERSION		Software version		
	NETWORK		Network parameters		
	RDM	UID	0x388Axxxxxxx	Fixture ID	
		LABEL		Fixture name	
	SYSTEM ERROR	MEMORY IC		Memory IC	
		ANGLESENSOR		Angle sensor	
		PAN SENSOR		X magnet	
		PAN ENCODER		X encoder	
		PAN DRIVEIC		X driver IC	
		TILT SENSOR		Y magnet	
		TILTENCODER		Y encoder	
		TILTDRIVEIC		Y driver IC	
		TEMPERATURE		Temperature control IC	
		CMY_C RESET			
		CMY_M RESET			
		CMY_Y RESET			
		COLOR RESET		COLOR reset	
		GOBO RESET			
		RGOBO RESET			
FIXED GOBO		Fixed gobo reset			
PRISM 1 RESET		Prism 1 reset			
PRISM 2 RESET		Prism 2 reset			
FOCUS RESET		Focus reset			

SERVICE	****	PAN	±127	
		TILT	±127	
		CMY-C	±127	
		CMY-M	±127	
		CMY-Y	±127	
		COLOR	±127	
		ROTA. GOBO	±127	
		GOBO.ROTA	±127	
		FIXED GOBO	±127	
		PRISM 1	±127	
		PRISM 2	±127	
		FROST	±127	
		FOCUS	±127	
UPDATE SOFTWARE			Allows for firmware updates. Instructions for firmware updates are provided together with the appropriate update files.	

## 9. DMX-CHART - CONTROLS

This is the DMX chart, highlighting the different DMX modes (corresponding to the PERSON settings in the menu):

BASIC (19CH)	STANDARD (23CH)	EXTENDED (27CH)	Value	Function
1	1	1	0-255	Pan 0 - 540°
-	2	2	0-255	Pan fine
2	3	3	0-255	Tilt 0 - 270°
-	4	4	0-255	Tilt fine
3	5	5	0-255	Pan-Tilt speed
4	6	6	0-255	Cyan
5	7	7	0-255	Magenta
6	8	8	0-255	Yellow
7	9	9	<b>COLOR MACRO (CMY mixture)</b>	
			0-10	Inactive / Open
			11-20	L106
			21-30	L194
			31-40	L019
			41-50	R08
			51-60	L213
			61-70	R80
			71-80	L202
			81-90	L328
			91-100	R3314
			101-110	L101
			111-120	L768
			121-128	No function
			129-147	Cyan 100% / Magenta 100% / Yellow 0%
			148-166	Cyan 0% / Magenta 100% / Yellow 0%
			167-185	Cyan 0% / Magenta 100% / Yellow 100%
186-204	Cyan 0% / Magenta 0% / Yellow 100%			
205-223	Cyan 100% / Magenta 0% / Yellow 100%			
224-242	Cyan 100% / Magenta 0% / Yellow 0%			
243-255	Cyan 100% / Magenta 100% / Yellow 0%			
8	10	10	0-255	CMY speed (Speed 100% -> 1%)
9	11	11	<b>COLOR WHEEL 19+1</b>	
			0-7	White / Open
			8-10	1. M Red
			11-13	2. B Red
			14-16	3. M Red X
			17-19	4. Orange
			20-22	5. DS Amber
			23-25	6. D Amber
			26-28	7. Yellow
			29-31	8. J Green
			32-34	9. Ch Green
			35-37	10. DY Green
			38-40	11. Prim Green
			41-43	12. J Blue
			44-46	13. M Blue
			47-49	14. Congo
			50-52	15. Indigo
53-55	16. Magenta			
56-58	17. Salmon			

BASIC (19CH)	STANDARD (23CH)	EXTENDED (27CH)	Value	Function
			59-61	18. 1/4 CTO
			62-64	19. 1/8 CTO
			65-191	Color wheel rotation 0 - 360° (clockwise)
			192-222	Color wheel rainbow effect (speed 100% -> 1%) clockwise
			223-224	Stop
			225-255	Color wheel rainbow effect (speed 1% -> 100%) counter-clockwise
-	-	12	0-255	Color wheel fine
10	12	13	<b>ROTATING GOBO 6+1</b>	
			0-10	White / Open
			11-19	Rotating GOBO 1 - Sun Blaze
			20-28	Rotating GOBO 2 - Ocean Waves
			29-37	Rotating GOBO 3 - Cotton Cluster
			38-46	Rotating GOBO 4 - Honeycomb
			47-55	Rotating GOBO 5 - Grid
			56-64	Rotating GOBO 6 - Drops
			65-73	Rotating GOBO 1 shake (speed 1% -> 100%)
			74-82	Rotating GOBO 2 shake (speed 1% -> 100%)
			83-91	Rotating GOBO 3 shake (speed 1% -> 100%)
			92-100	Rotating GOBO 4 shake (speed 1% -> 100%)
			101-109	Rotating GOBO 5 shake (speed 1% -> 100%)
			110-118	Rotating GOBO 6 shake (speed 1% -> 100%)
			119-127	White / Open
			128-190	Rotating GOBO flowing water effect (speed 100% -> 1%) clockwise
			191-192	Stop rotation
			193-255	Rotating GOBO flowing water effect (speed 1% -> 100%) counter-clockwise
-	-	14	0-255	Rotating GOBO fine
11	13	15	<b>GOBO ROTATION</b>	
			0-120	Rotating GOBO angle (0° -> 360°)
			121-125	Stop
			126-165	Rotating GOBO shake (speed 1% -> 100%)
			166-170	Stop
			171-210	Rotating GOBO clockwise rotation (speed 100% -> 1%)
			211-215	Stop
			216-255	Rotating GOBO counter-clockwise rotation (speed 1% -> 100%)
-	-	16	0-255	GOBO rotation fine
			<b>FIXED GOBO WHEEL 19+1</b>	
			0-10	White / Open
			11-13	Fixed GOBO 1 - Vertical Line
			14-16	Fixed GOBO 2 - Horizontal Line
			17-19	Fixed GOBO 3 - Dot Square
			20-22	Fixed GOBO 4 - Circle
			23-25	Fixed GOBO 5 - Radioactive
			26-28	Fixed GOBO 6 - Square
			29-31	Fixed GOBO 7 - Wave
			32-34	Fixed GOBO 8 - Three Lines
			35-37	Fixed GOBO 9 - Triangle
			38-40	Fixed GOBO 10 - Square Outline
			41-43	Fixed GOBO 11 - Asterisk
			44-46	Fixed GOBO 12 - Radioactive 2
			47-49	Fixed GOBO 13 - Star
			50-52	Fixed GOBO 14 - Triangular Lines
			53-55	Fixed GOBO 15 - Drum brake
			56-58	Fixed GOBO 16 - Three-Swirl
			59-61	Fixed GOBO 17 - Pinhole Medium
			62-64	Fixed GOBO 18 - Pinhole Small
			65-67	Fixed GOBO 19 - Pinhole Super Small

BASIC (19CH)	STANDARD (23CH)	EXTENDED (27CH)	Value	Function
12	14	17	68-70	Fixed GOBO 1 shake (speed 1% -> 100%)
			71-73	Fixed GOBO 2 shake (speed 1% -> 100%)
			74-76	Fixed GOBO 3 shake (speed 1% -> 100%)
			77-79	Fixed GOBO 4 shake (speed 1% -> 100%)
			80-82	Fixed GOBO 5 shake (speed 1% -> 100%)
			83-85	Fixed GOBO 6 shake (speed 1% -> 100%)
			86-88	Fixed GOBO 7 shake (speed 1% -> 100%)
			89-91	Fixed GOBO 8 shake (speed 1% -> 100%)
			92-94	Fixed GOBO 9 shake (speed 1% -> 100%)
			95-97	Fixed GOBO 10 shake (speed 1% -> 100%)
			98-100	Fixed GOBO 11 shake (speed 1% -> 100%)
			101-103	Fixed GOBO 12 shake (speed 1% -> 100%)
			104-106	Fixed GOBO 13 shake (speed 1% -> 100%)
			107-109	Fixed GOBO 14 shake (speed 1% -> 100%)
			110-112	Fixed GOBO 15 shake (speed 1% -> 100%)
			113-115	Fixed GOBO 16 shake (speed 1% -> 100%)
			116-118	Fixed GOBO 17 shake (speed 1% -> 100%)
			119-121	Fixed GOBO 18 shake (speed 1% -> 100%)
			122-124	Fixed GOBO 19 shake (speed 1% -> 100%)
			128-190	Static GOBO auto-rotation (speed 100% -> 1%) clockwise
			191-192	Stop auto-rotation
			193-255	Static GOBO auto-rotation (speed 1% -> 100%) counter-clockwise
-	-	18	0-255	Static GOBO Wheel fine
13	15	19	<b>PRISM 1: 6-Facet Linear Prism</b>	
			0-10	Open
			11-145	Prism insert and angle adjustment (0 -> 360°) clockwise
			146-150	Stop
			151-200	Prism insert and clockwise (speed 100% -> 1%)
			201-205	Stop rotation
			206-255	Prism insert and counter-clockwise rotation (speed 1% -> 100%)
14	16	20	<b>PRISM 2: 16-Facet Radial Prism</b>	
			0-10	Open
			11-145	Prism insert and angle adjustment (0 -> 360°) clockwise
			146-150	Stop
			151-200	Prism insert and clockwise (speed 100% -> 1%)
			201-205	Stop rotation
			206-255	Prism insert and counter-clockwise rotation (speed 1% -> 100%)
15	17	21	<b>FROST</b>	
			0-10	Open
			11-145	Frost insert and angle adjustment (0 -> 360°) clockwise
			146-150	Stop
			151-200	Frost insert and clockwise (speed 100% -> 1%)
			201-205	Stop rotation
			206-255	Frost insert and counter-clockwise rotation (speed 1% -> 100%)
16	18	22	0-255	Focus
-	19	23	0-255	Focus fine
17	20	24	0-255	Dimmer / Intensity
-	21	25	0-255	Dimmer / Intensity fine

BASIC (19CH)	STANDARD (23CH)	EXTENDED (27CH)	Value	Function
18	22	26	<b>STROBE</b>	
			0-9	Inactive / No strobe
			10-99	Strobe, increasing speed from slow to fast
			100-109	Inactive
			110-179	Lightning Strobe
			180-189	Inactive
			190-255	Random Strobe
19	23	27	<b>CONTROL</b> (commands effective after 3 seconds)	
			0-10	Inactive
			11-20	Pan/Tilt Black activated
			21-30	Pan/Tilt Black deactivated
			31-40	Pan invert
			41-50	Tilt invert
			51-60	Pan/Tilt invert off
			61-70	Studio mode
			71-80	Power mode
			81-90	Live mode
			91-100	Reserved
			101-110	Dim 4
			111-120	Off
			121-130	Reserved
			131-140	Reserved
			141-150	Reserved
			151-160	PWM 1200Hz
			161-170	PWM 2400Hz
			171-180	PWM 4000Hz
			181-190	PWM 6000Hz
			191-200	PWM 25000Hz
			201-210	All reset
			211-220	XY reset
			221-230	Color System reset
231-240	Gobo System reset			
241-255	Other reset			

Ready-made fixture profiles / personalities can either be found in the latest libraries of your DMX controller or on [www.tarm.com](http://www.tarm.com)

## 10. W-DMX OPERATION

This product is equipped with a wireless DMX receiver TiMo RX by Lumenradio. To establish a connection, put your transmitter device into a pairing state and then select the Menu option of the device **OPTION > WDMX RESET > YES**.

This pairs the device to the transmitter.

Make sure to only use compatible transmitter or transceiver devices!

Please refer to the Lumenradio support website if any wireless DMX configuration issues arise besides the basic connection or if you need to learn more about compatible transmitters or transceivers.



## 11. COLORS

### 11.1. Color Wheel

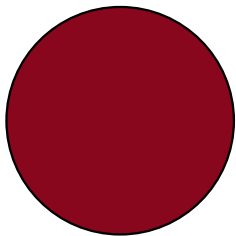

1. M Red  
~ E787

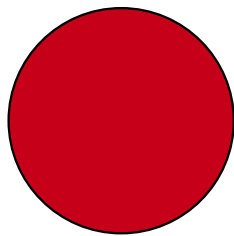

2. B Red  
~ E026

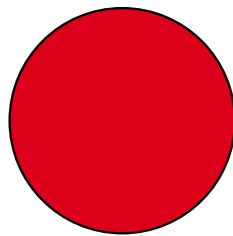

3. M Red X  
~ G250

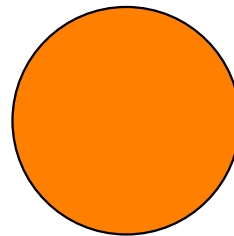

4. Orange  
~ E105

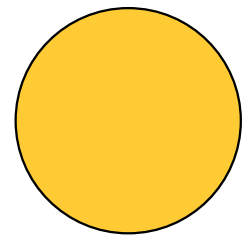

5. DS Amber  
~ E015

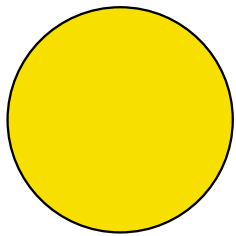

6. D Amber  
~ 104

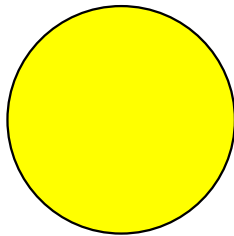

7. Yellow  
~ E101

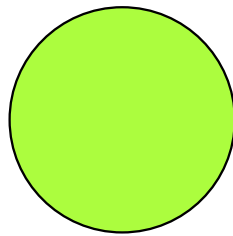

8. J Green  
~ 738

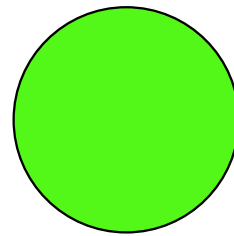

9. Ch Green  
~ R389

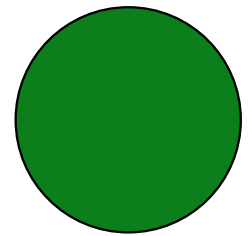

10. DY Green  
~ R90

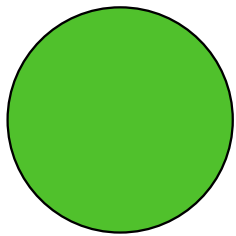

11. Prime Green  
~ 139

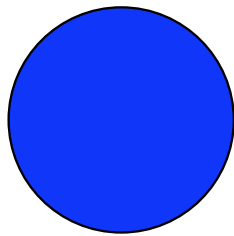

12. J Blue  
~ R79

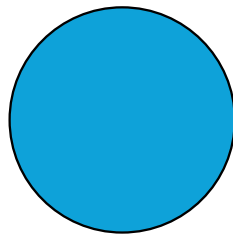

13. M Blue  
~ 132

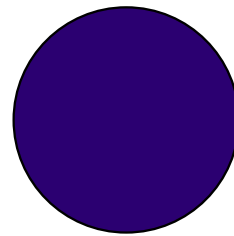

14. Congo  
~ R382

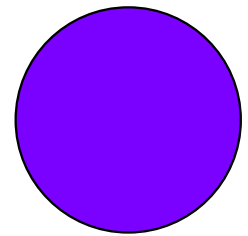

15. Indigo  
~ R59

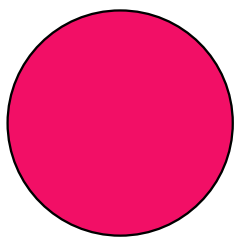

16. Magenta

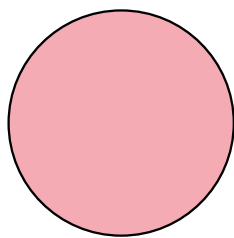

17. Salmon

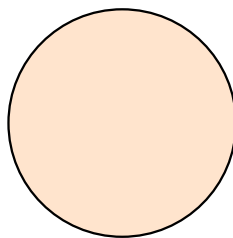

18. 1/4 CTO

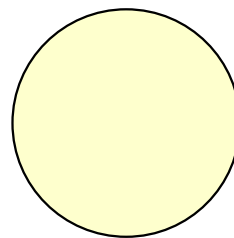

19. 1/8 CTO

### 11.2. CMY Color Mixture

This product is equipped with a **CMY color mixture unit**. This type of color mixture allows for creating a multitude of different color tones. A **Cyan (C)**, a **Magenta (M)** and a **Yellow (Y)** wheel, each with a colored intensity gradient applied, can be used for mixing many different colors. This color mixture is available in addition to the color wheel (see above).

## 12. GOBOS

### 12.1. Static Gobos, with Gobo Shake

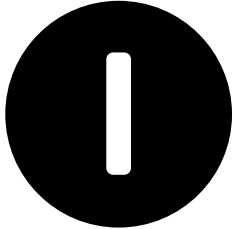

1. Vertical Line

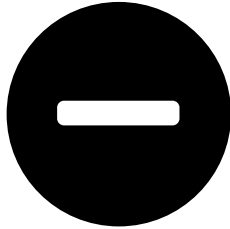

2. Horizontal Line

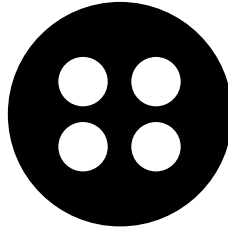

3. Dot Square

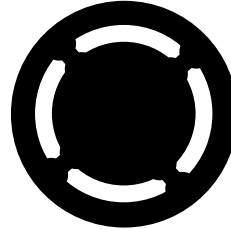

4. Circle



5. Radioactive

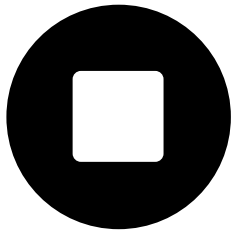

6. Square

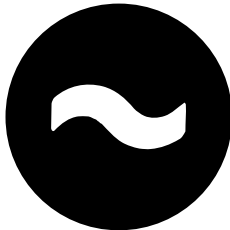

7. Wave

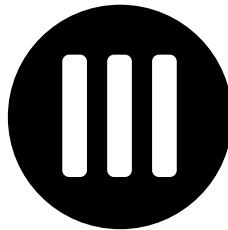

8. Three Lines

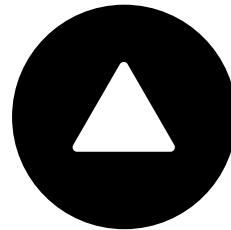

9. Triangle

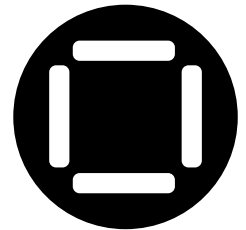

10. Square Outline

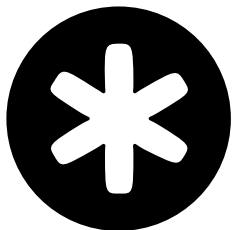

11. Asterisk

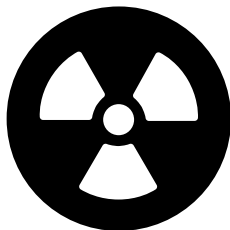

12. Radioactive 2

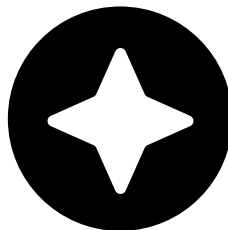

13. Star

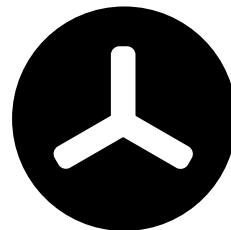

14. Triangular Lines

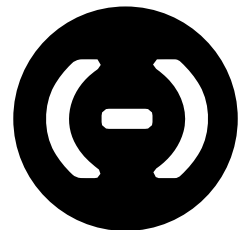

15. Drum brake



16. Three-Swirl

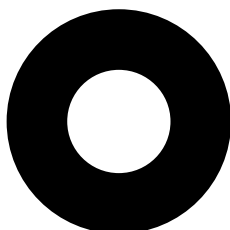

17. Pinhole Medium

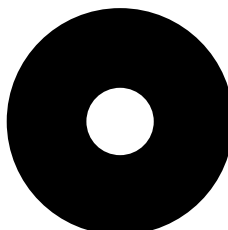

18. Pinhole Small

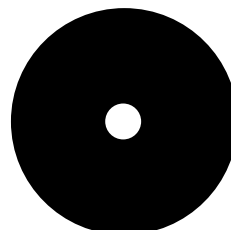

19. Pinhole Super Small

## 12.2. Rotating Gobos, Effects

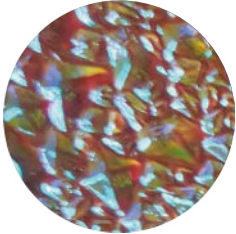

1 . Sun Blaze

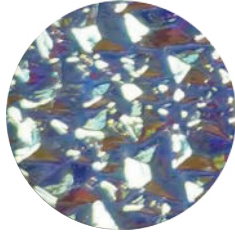

2. Ocean Waves

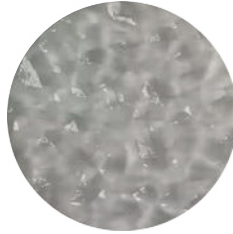

3 . Cotton Cluster

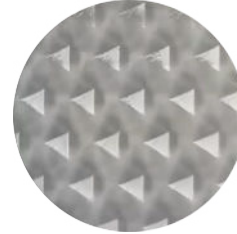

4. Honeycomb

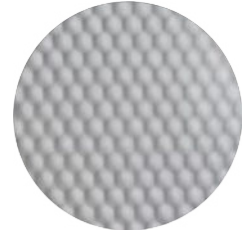

5. Grid

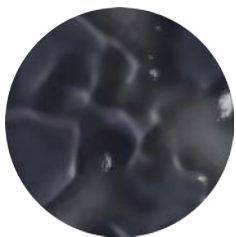

6. Drops

## 13. PRISMS

This product is equipped with **two prism units**, which are stackable, so they can be overlaid with each other and with frost.

### 13.1. Prism 1 - Linear prism

This is a **6-facet rotating linear prism**. It creates six times the projection in a line. The prism can be rotated, the speed can be adjusted.

### 13.2. Prism 2 - Radial prism

This is a **16-facet rotating radial prism**. It creates 16 times the projection arranged in a circle. The prism can be rotated, the speed can be adjusted.

## 14. FROST

The **frost filter can be stacked with the prisms**. This device has a rotating frost filter that goes well together with the rotating glass effects Gobos.

## 15. DIMENSIONS

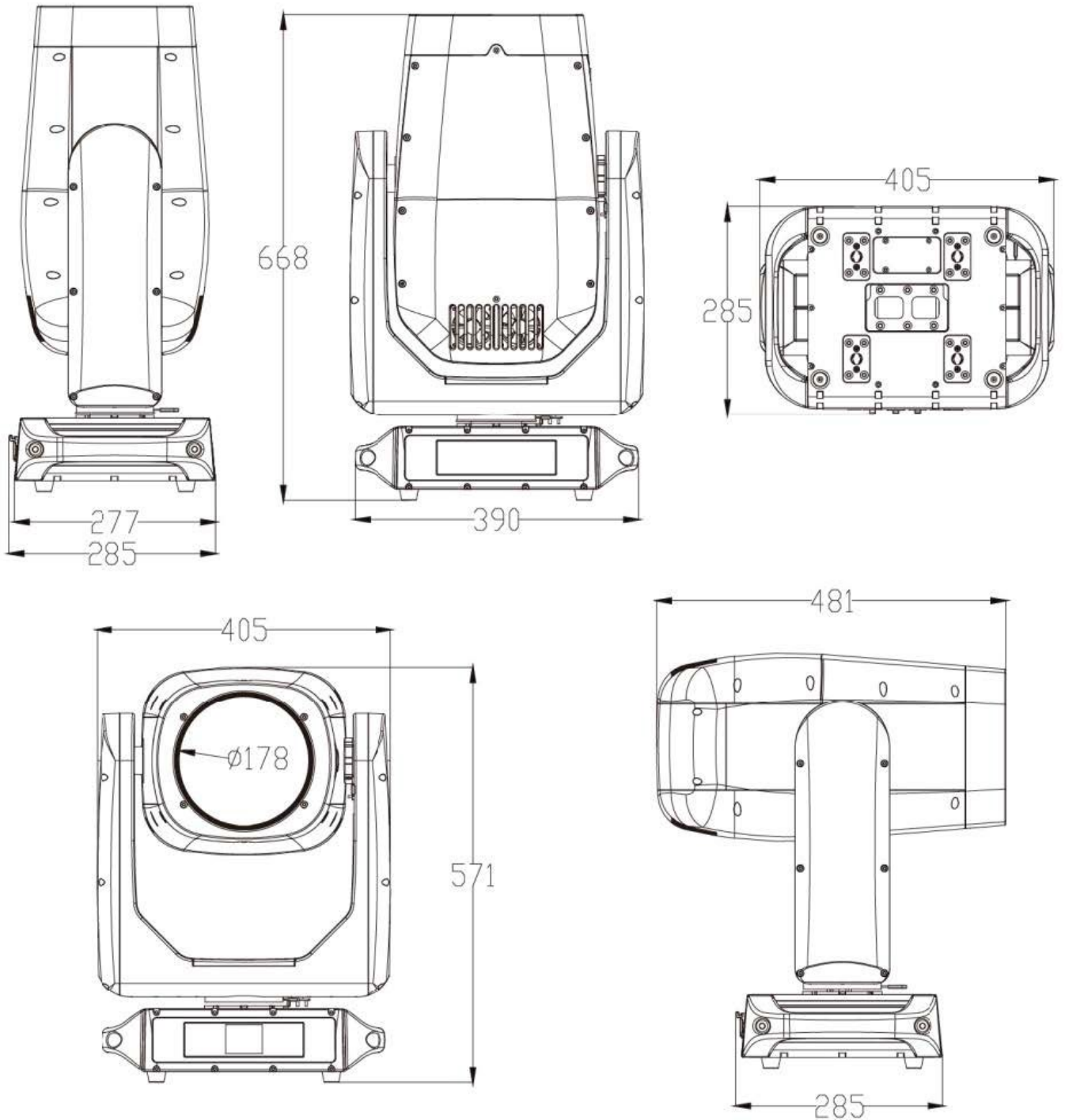

Dimensions given in millimeters.

## 16. FLIGHTCASE INLAY - HIGH DENSITY PU FOAM SHELL

This product comes standard in a high density PU foam shell, it is **part of the packaging you received the product in**. This PU foam is designed to fit in custom flightcases to protect the product (flightcase inlay).

The product is inserted from the top, with the head tilted by 90°.

Below graphics show the dimensions of that PU foam to ease the ordering of custom flightcases.

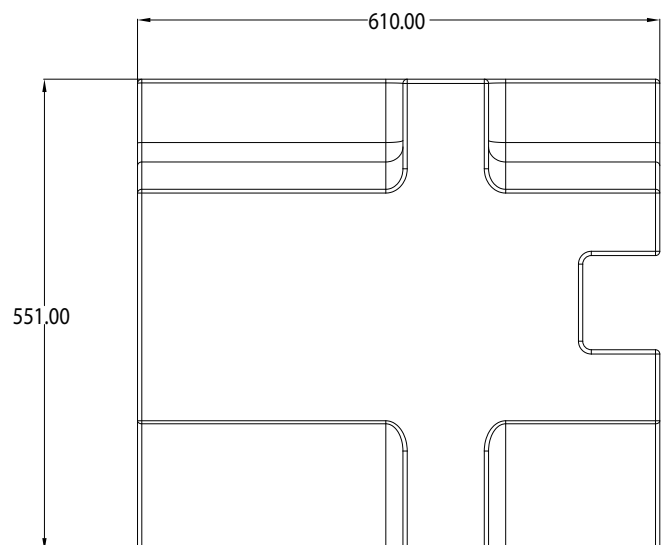
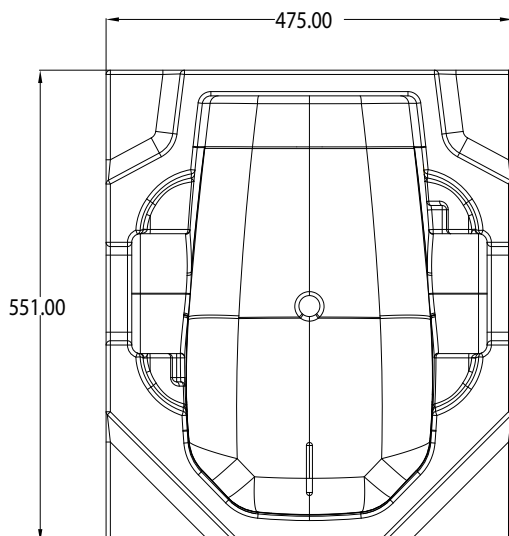
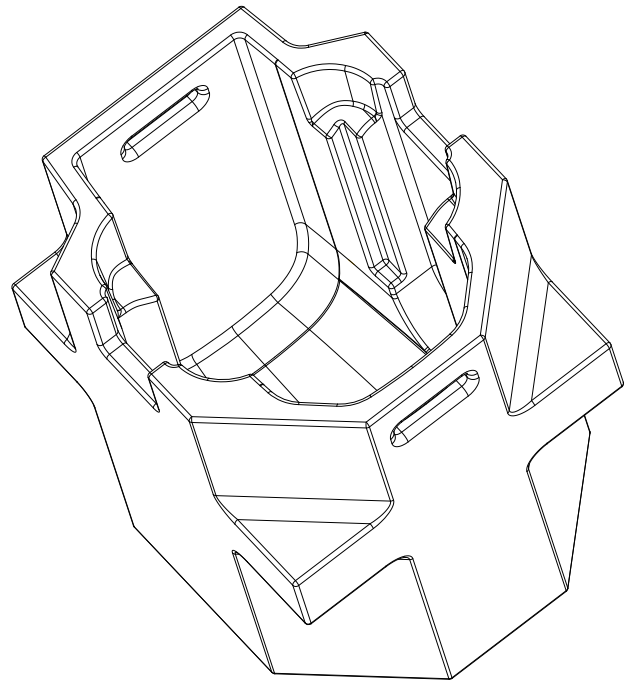
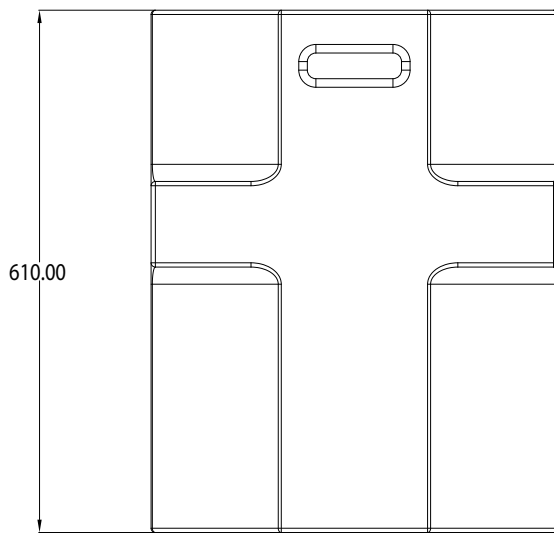

Dimensions given in millimeters.

## 17. TECHNICAL DATASHEET

Product: tarm BLAZE

### Optical System

Light source	100 W White Laser Engine
Lens diameter	180 mm
Angle	0.7 - 5°
Illuminance	220'000 lx @ 20m, 0.7°
Luminous flux	≥ 3000 lm
CRI	> 65
Color temperature	6500K
Rated life (LP70)	12'000 hrs

### Feature Set

Pan / Tilt	540° / 270° (8-16 bit)
Dimmer	0 - 100%, 24bit
Static Gobo	19 gobos + open
Rotating Gobo	6 rotating effects gobos, gobo shake
Colors	Color wheel 19 colors, incl. CTO, + white, rainbow flow effect
Color mixture	CMY-mixture
Prism	16 facet radial prism, 6 facet linear prism, bi-directional rotation, adjustable speed, stackable
Frost	Frost filter, bi-directional rotation

### Constructive Parameters

Cooling	Forced convection
Temperature range	-20°C up to +45°C
IP rating	IP66
Power supply	100 - 240 V AC 50/60Hz
Power consumption	240 W
Connectivity	5-pin DMX in and through RJ45 in and through, USB-C
Material	Magnalium and die-cast
Color	Black
Dimensions	381 x 280 x 665 mm
Weight	24 kg
Rigging	Two omega brackets included
Transportation	Delivered in High Density Foam Shell

### Control Modes

DMX512, Art-Net, RDM, sACN, W-DMX

## 18. GENERAL AND LEGAL INFORMATION

### **tarm AG**

In der Halde 4  
8268 Salenstein  
Switzerland

UID: CHE-422.406.186  
CH-ID: CH-130-3019611-6  
CEO: Martin Werner



Representative in the European Union:  
tarm laser technologies tlt GmbH & Co. KG  
Lindenallee 27  
44625 Herne  
Germany

© tarm AG 2024 - All rights reserved. The images, specifications, information, charts, and instructions contained in this document are subject to change without notice. The tarm logo and any product names and numbers mentioned herein are trademarks of tarm AG or other companies of the Laserworld Group. Copyright protection is claimed for all forms of copyrightable material and information currently protected by statutory or judicial law, as well as any future provisions. Product names mentioned in this document may be trademarks or registered trademarks of their respective companies, which are hereby acknowledged. All brands and product names not affiliated with tarm are also acknowledged as trademarks or registered trademarks of their respective holders

The tarm AG and its affiliated companies expressly disclaim any liability for damages to property, equipment, buildings, and electrical systems, injuries to individuals, or direct or indirect economic losses that may arise from using or relying on any information in this document. This also includes losses or damages resulting from improper, unsafe, inadequate, or negligent assembly, installation, rigging, and operation of this product.

An updated version of this document may be available online due to product updates. Please visit [www.tarm.com](http://www.tarm.com) for the latest version.